

136mm x 116mm

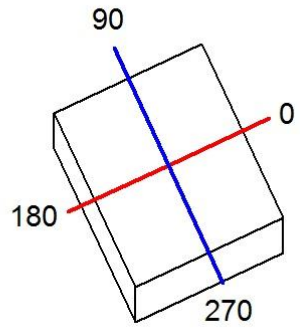

C Halfplanes

180.0 — 0.0

270.0 — 90.0

Flux 2500.00 lm

Maximum 433.20 cd/klm

Position C=90.00 G=3.00

Efficiency: 100.00%

Date: 11-04-2016

Asymmetrical

